



	CPC1945G	Units
AC Operating Voltage	120	$V_{RMS}$
Load Current	1.0	A
On-State Voltage Drop	1.6	$V_{RMS}$ (at $I_L=1.0A$ )

### Features

- Load Current up to 1A
- Blocking Voltage to 400V
- 5mA Sensitivity
- Zero-Crossing Detection
- DC Control, AC Output
- Optically Isolated
- TTL and CMOS Compatible
- Low EMI and RFI Generation
- High Noise Immunity
- Machine Insertable, Wave Solderable
- Flammability classification rating V-0

### Applications

- Programmable Control
- Process Control
- Power Control Panels
- Remote Switching
- Gas Pump Electronics
- Contractors
- Large Relays
- Solenoids
- Motors
- Heaters

### Description

The CPC1945G is a AC Solid State Switch using patented waveguide coupling with dual power SCR outputs to produce an alternative to optocoupler and Triac circuits. The CPC1945G switches are robust enough to provide a blocking voltage of up to 400V. In addition, tightly controlled zero cross circuitry ensures switching of AC loads without the generation of transients. The input and output circuits are optically coupled to provide 3750V of isolation and noise immunity between control and load circuits. As a result the CPC1945G is well suited for industrial environments where electromagnetic interference would disrupt the operation of electromechanical relays.

### Approvals

- UL recognized to UL508, file #: E69938
- CSA certified to CSA14, file #: LR43639

### Ordering Information

Part #	Description
CPC1945G	16 Pin DIP (25/tube)

### Pin Configuration

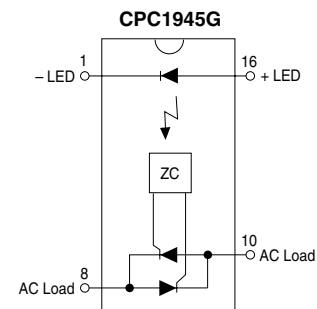

### Absolute Maximum Ratings (@ 25° C)

Parameter	Min	Typ	Max	Units
Input Power Dissipation	-	-	150 <sup>1</sup>	mW
Input Control Current	-	-	100	mA
Peak (10ms)	-	-	1	A
Reverse Input Voltage	-	-	5	V
Total Package Dissipation PD	-	-	1600 <sup>2</sup>	mW
Isolation Voltage Input to Output	3750	-	-	V <sub>RMS</sub>
Operational Temperature	-40	-	+85	°C
Storage Temperature	-40	-	+125	°C
Soldering Temperature (10 Seconds Max.) DIP Package	-	-	+260	°C

<sup>1</sup> Derate Linearly 1.33 mW/°C

<sup>2</sup> Derate Linearly 16.6 mW/°C

Absolute Maximum Ratings are stress ratings. Stresses in excess of these ratings can cause permanent damage to the device. Functional operation of the device at conditions beyond those indicated in the operational sections of this data sheet is not implied.

### Electrical Characteristics

Parameter	Conditions	Symbol	Min	Typ	Max	Units
<b>Output Characteristics @ 25°C</b>						
Operating Voltage Range	$V_T$		20	-	120	V <sub>RMS</sub>
Peak Blocking Voltage	-	$V_{DRM}$	-	-	400	V
Load Current (Continuous)	$V_L=120VAC$	$I_L$	0.005	-	1.0	A <sub>RMS</sub>
Non-repetitive Single Cycle Surge Current	-	$I_{TSM}$	-	-	10	A
Off State Leakage Current	$V_{DRM}$	$I_{LEAK}$	-	-	1	mA
On-State Voltage Drop	$I_L=1.0A$		-	-	1.6	V <sub>RMS</sub>
Critical Rate of Rise <sup>3</sup>		dv/dt	1000	-	-	V/μs
Switching Speeds						
Turn-on	$I_F=5\text{ mA}$	$T_{ON}$	-	-	0.5	Cycles
Turn-off	$I_F=5\text{ mA}$	$T_{OFF}$	-	-	0.5	Cycles
Zero-Cross Turn-On Voltage	1st half cycle		-	2	10	V
Sub. half cycle			-	1	V	
Operating Frequency <sup>1</sup>	-		20	-	400	Hz
Load Power Factor for Guaranteed Turn-On <sup>2</sup>	-	PF	0.25	-	-	-
Capacitance Input to Output	-	-	-	3	-	pF
<b>Input Characteristics @ 25°C</b>						
Input Control Current For Normal Environment	-	$I_F$	5	-	50	mA
For High Noise Environment	-	$I_F$	10	-	100	mA
Input Voltage Drop	$I_F=5mA$	$V_F$	0.9	1.2	1.4	V
Input Drop-out Voltage	-		0.8	-	-	V
Reverse Input Current	$V_R=5V$	$I_R$	-	-	10	μA

<sup>1</sup> Zero cross 1st 1/2 cycle @ <100Hz

<sup>2</sup> Snubber circuits may be required at low power factors.

<sup>3</sup> Tested in accordance with EIA/NARM Standard RS-443.

PERFORMANCE DATA\*

**CPC1945G**  
Typical LED Forward Voltage Drop  
(Ambient Temperature = 25°C)  
 $I_F = 5\text{mA}$

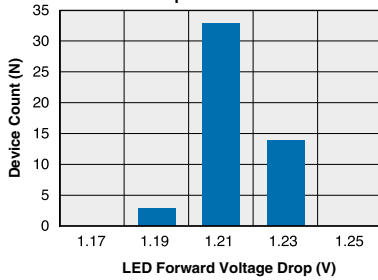

**CPC1945G**  
Typical On-State Output  
Forward Voltage Distribution  
(Ambient Temperature = 25°C)

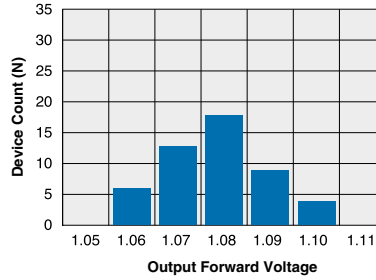

**CPC1945G**  
Typical Blocking Voltage Distribution  
(Ambient Temperature = 25°C)

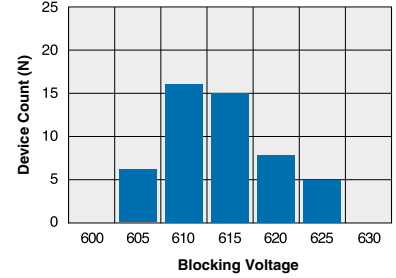

**CPC1945G**  
Typical  $I_F$  for Switch Operation  
(Ambient Temperature = 25°C)

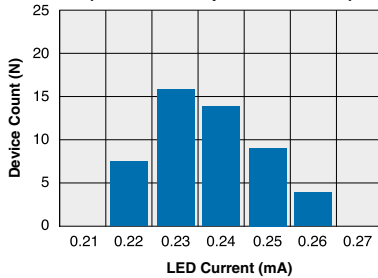

**CPC1945G**  
Typical Maximum Load  
Current vs. Temperature

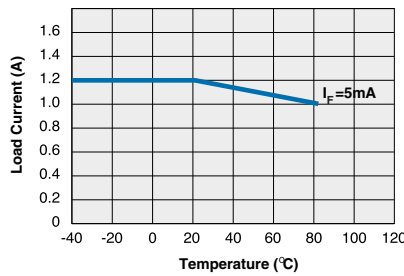

**CPC1945G**  
Typical Leakage vs. Temperature  
@ Maximum Rated Load Voltage

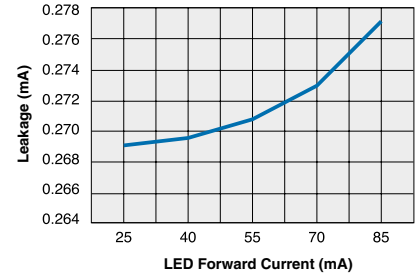

**CPC1945G**  
Typical Blocking Voltage  
vs. Temperature

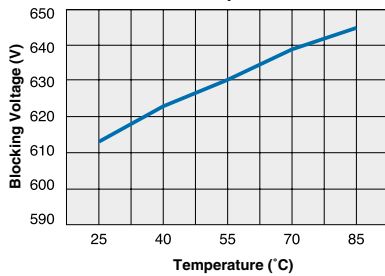

**CPC1945G**  
Typical Output  $V_F$  vs. Temperature

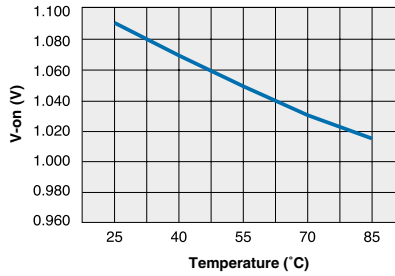

**CPC1945G**  
Typical LED Forward Voltage Drop  
vs. Temperature

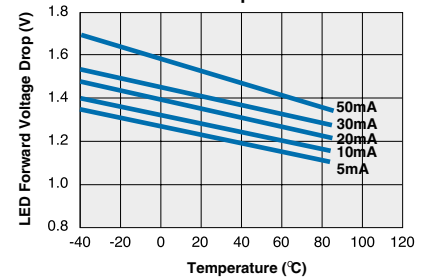

**CPC1945G**  
Maximum Surge Current (non-repetitive)  
( $T_J = 50^\circ\text{C max}$ )

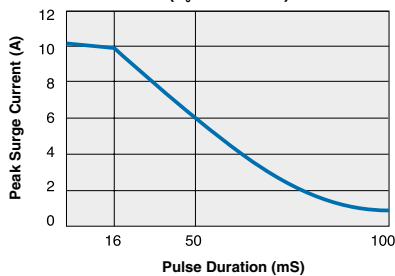

**CPC1945G**  
Typical  $I_F$  for Switch Operation  
Over Temperature

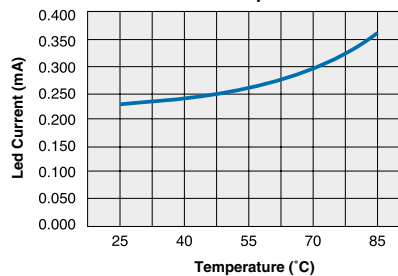

\* The Performance data shown in the graphs above is typical of device performance. For guaranteed parameters not indicated in the written specifications, please contact our application department.

MECHANICAL DIMENSIONS

16 Pin DIP

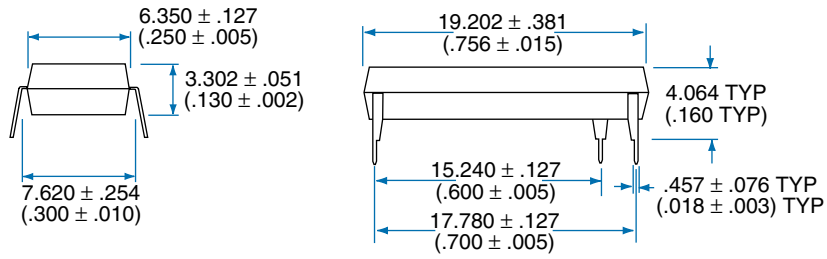

Dimensions  
mm  
(inches)



# CLARE

---

**For additional information please visit our website at: [www.clare.com](http://www.clare.com)**

*Clare, Inc. makes no representations or warranties with respect to the accuracy or completeness of the contents of this publication and reserves the right to make changes to specifications and product descriptions at any time without notice. Neither circuit patent licenses nor indemnity are expressed or implied. Except as set forth in Clare's Standard Terms and Conditions of Sale, Clare, Inc. assumes no liability whatsoever, and disclaims any express or implied warranty, relating to its products including, but not limited to, the implied warranty of merchantability, fitness for a particular purpose, or infringement of any intellectual property right.*

*The products described in this document are not designed, intended, authorized or warranted for use as components in systems intended for surgical implant into the body, or in other applications intended to support or sustain life, or where malfunction of Clare's product may result in direct physical harm, injury, or death to a person or severe property or environmental damage. Clare, Inc. reserves the right to discontinue or make changes to its products at any time without notice.*

Specification: DS-CPC1945G-R3.0  
©Copyright 2002, Clare, Inc.  
OptoMOS<sup>®</sup> is a registered trademark of Clare, Inc.  
All rights reserved. Printed in USA.  
12/18/02